



Application Note

Application Note Number	E-HO-TFE731-2-4040-FB-1.0
Version	1.0
Function	Fan Trim Balance
Airframe	Various
Engine	TFE731-2
E-Setup Number	E-HO-TFE731-2-4040-FB-1.0
ACES Systems Analyzer	Viper 4040
Firmware Version	1.04 or higher
Procedure	N/A

Introduction

This Application Note is required to perform a fan trim balance on all airframes with TFE731-2 engines. This Application Note describes the steps necessary for correctly setup the analyzer and conduct the job.

Required Equipment: The following equipment is required to accomplish a single engine fan trim balance.

Item	Quantity	Description	Part Number
1.	1EA	Analyzer, Viper 4040	10-100-4040
2.	1EA	Cable, Vibe, 6 Pin Generic, 50 Ft.	10-320-0127
3.	1EA	Tachometer, Lasetach II, 299 (Reflective tape included)	10-100-1300
4.	1EA	Mount, Lasetach Swivel	10-100-0369
5.	1EA	Cable, Tachometer, Generic, 50 Ft.	10-320-0126
6.	1EA	Interface, (SENSOR SPECIFIC) See Optional Equipment below or call ACES.	TBD
7.	1EA	BOLTS, TFE731-2, THRU-5 VIBE SENS MOUNT (2 Bolts)	Z22-430-0062
8.	1EA	MOUNT, SENSOR, TFE731-2, THRU -5 1/4X28	22-430-0061
9.	1EA	Sensor, Vibration (See Optional Equipment below or call ACES)	TBD

Optional Equipment: The following items are optional sensor and sensor interface cables. You may choose either sensor and interface combination. if you are conducting a dual engine balance job, double the number of items 2 thru 9 above.

10.	1EA	Sensor, Vibe, Velo, 991V	69-100-0064
11.	1EA	Sensor, Vibe Accel, 793	69-100-0062
12.	1EA	CABLE, INTERFACE, 793/797/M99-TO-GEN. VIBE CBL	10-320-0134
13.	1EA	CABLE, INTERFACE, 991V - GEN VIB CBL, 1725/1730	10-320-0142

A. Equipment Set Up

1. Select an unused forward engine mount location on engine support housing and install the Vibration Sensor Mount, item 8, using the two bolts, item 7.

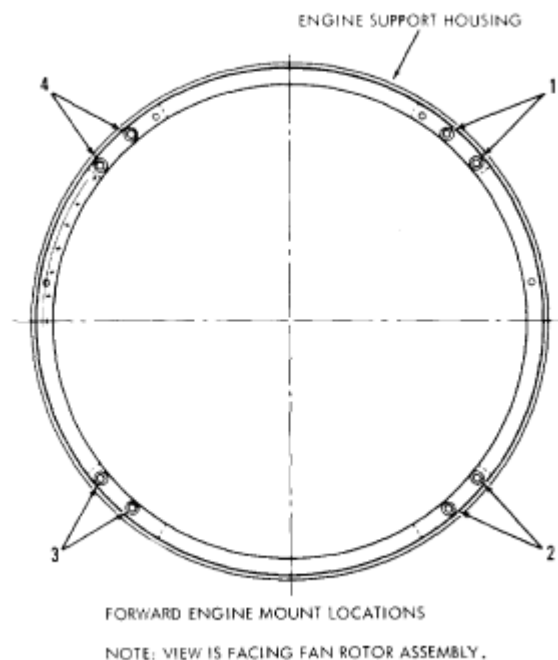

2. Install the selected vibration sensor, item 10 or 11, on the vibration sensor mount. Be sure the sensor is perpendicular to the center of the engine.
3. Connect the appropriate interface cable, item 12 or 13, to the selected sensor.
4. Connect the interface cable, item 12 or 13, to the socket end of the Generic Vibe Cable, item 2. Route the Generic Vibe Cable, item 2, to the cockpit or position where the analyzer will be located. Avoid hot areas and high voltage components in the routing. Secure the cable every 36 inches to the fuselage with duct or speed tape to avoid movement or possible ingestion into the engine.
5. If necessary, assemble the Lasetach, item 3, and Lasetach swivel mount, item 4.

6. Secure the base of the Lasetach mount to the wing or fuselage where there is a clear line of sight to the spinner on the engine. Secure the base to the surface using duct tape or speed tape on all four sides.
7. Connect the Lasetach cable to the Generic Tachometer Cable, item 5, at the socket end.
8. Route the Generic Tachometer Cable to the cockpit or position where the analyzer will be located. Secure the cable every 36 inches to the fuselage with duct or speed tape to avoid movement or possible ingestion into the engine.
9. Index the spinner with the fan and mark it, then remove the spinner to gain access to the installed trim balance weights. If any trim balance weights are presently installed on the fan, remove them. Note the alignment of the weight placement bolts and remember which hole lines up exactly with one of the spinner attaching bolt holes. Designate the aligned hole as hole #1. Reinstall the spinner in accordance with LMM guidelines and referencing the index mark make earlier prior to removal.

NOTE

Reflective quality is not the same for all reflective tape. Use only 3M brand, #7610 for best results.

10. On the engine spinner, draw an imaginary line from the center of the spinner to the center of hole #1 as determined above in step 9. Clean the surface of the spinner with a degreaser and dry thoroughly. Align the leading edge of a two-inch length of reflective tape with the imaginary line. Remove the protective backing from the tape and apply at this location. (See Figure below.) The bolt aligned with the tape is now designated #1 hole. The remaining numbers, 2 through 8, are in a counterclockwise ascending order, from forward looking aft, as shown in the drawing below. Alignment of the laser will be accomplished later in this procedure.
11. Connect the Generic Vibe Cable, item 2, to the Channel A vibration input of the 4040 Analyzer, item 1.
12. Connect the Generic Tachometer Cable, item 5, to the TACH 1 input of the 4040 Analyzer, item 1.

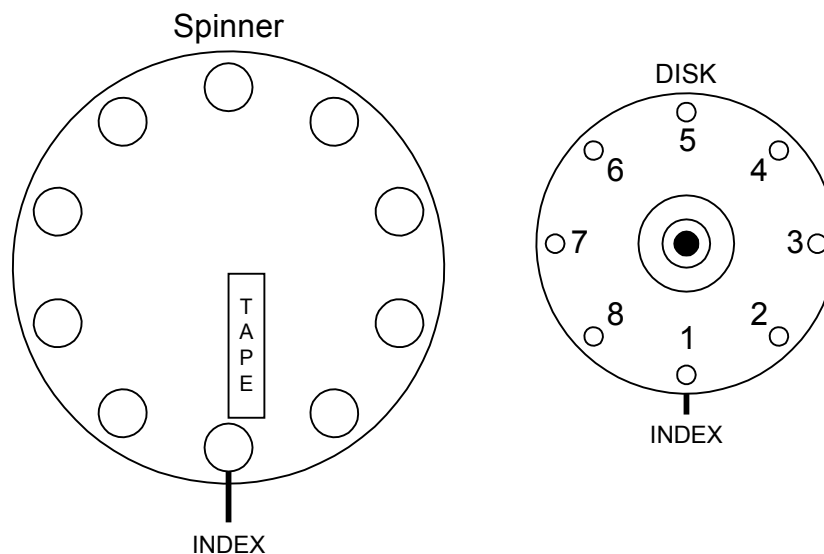

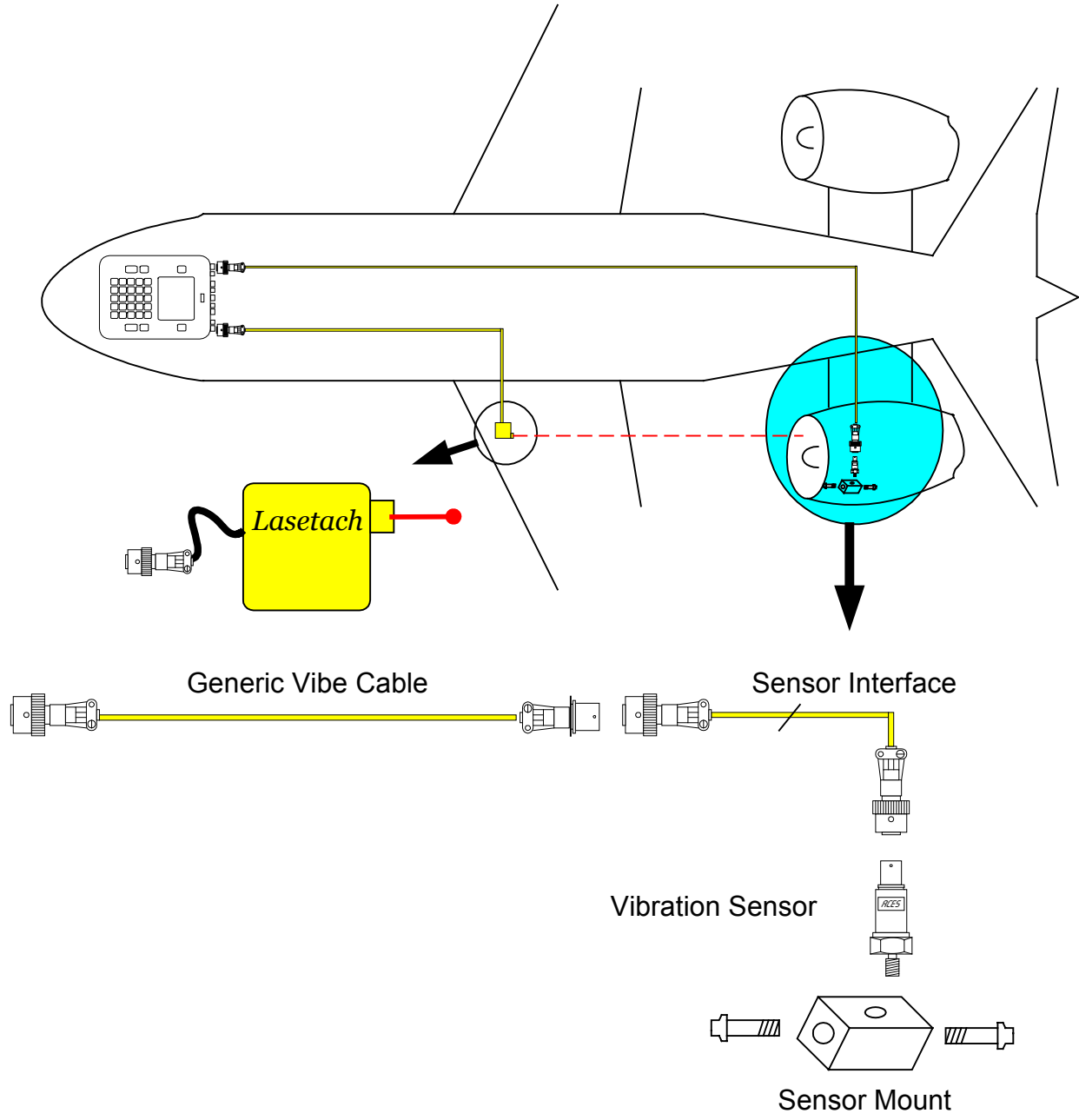

B. Analyzer Set Up

13. Fan Balance Setup.

- 14 This section will provide you with the steps to enter the Setup into the Viper Analyzer. If the setup has been previously entered, you need not repeat this step. If the setup is available, go to section C. Data Acquisition. Otherwise proceed to item 15 below.
15. Turn the analyzer on by pressing the ON/OFF key.
16. The analyzer has several default sensors already in memory. Other sensors may have also been programmed into the analyzer. To view the list of sensors already stored in the analyzers memory, do the following:
17. From the Main Menu, select Miscellaneous Items.

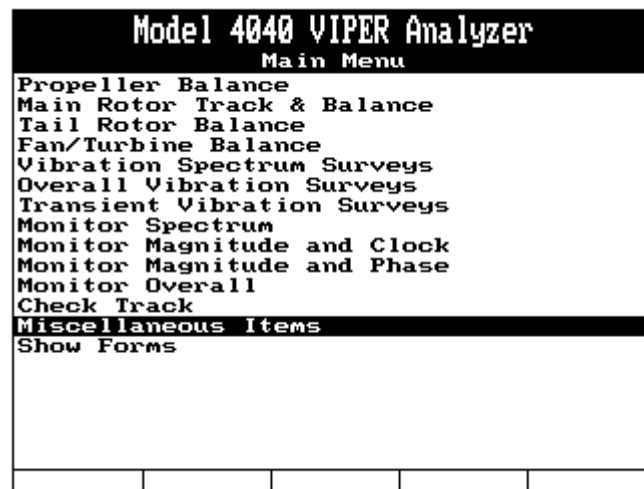

18. From the Miscellaneous items menu, select Setup Sensors, then press [ENTER].

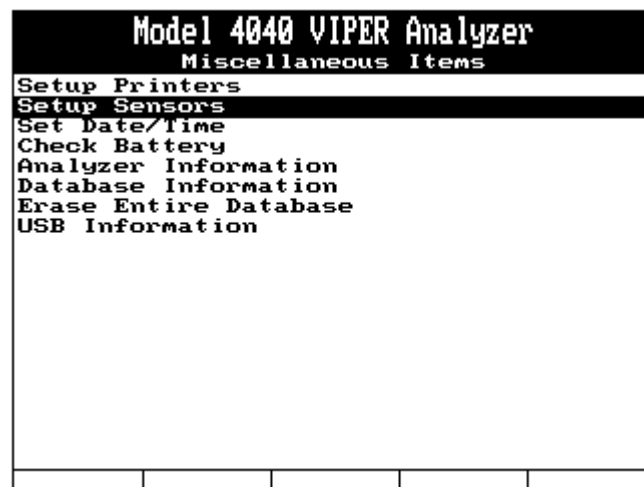

19. From the Manage Sensors menu, select Edit, then press [ENTER].

Model 4040 VIPER Analyzer				
Manage Sensors				
Edit				
New				
Print				
Print All				
Delete				

20. The Select menu will be displayed which lists all sensors currently programmed into the analyzers memory. If the sensor you are using is listed, you need not re-enter it. Go to item **XXX**, otherwise press the [BACKUP] key, select New from the Manage Sensors menu and proceed with item 21 below.

Select				
1	>	793		
2	>	AS907 ONBOARD		
3	>	991D-1		
4	>	991V		
5	>	797V		
6	>	BK 4383 W/510-2		
7	>	CH 7310		
		New		

21. Complete the Sensor Setup screen, shown below, as follows:

In the **Name:** field, enter the sensor name (793 or M99 for instance) Press the ↓ key to move to the next field.

Model 4040 VIPER Analyzer
Sensor Setup

Name: 793

Amplitude Units: g's

Probe Sensitivity: 100.000

Reverse Polarity: No

Input Type: Single Ended

In the **Amplitude Units:** field, use the \Rightarrow key to select units for the sensor. This is the engineering unit of output for the sensor such as g.'s for an accelerometer or IPS for a velocity sensor. Press the \Downarrow key to move to the next field.

In the **Probe Sensitivity:** field, enter the mV per engineering unit as specified on the data sheet for the sensor you are using, such as 100 for 100 mV/g. Press the \Downarrow key to move to the next field.

In the **Reverse Polarity:** field, use the \Rightarrow key, if necessary, to select "Yes or No" as appropriate for the sensor you are using. This will normally be "No" indicating the sensor polarity is not reversed. Press the \Downarrow key to move to the next field.

In the **Input Type:** field, use the \Rightarrow key, as necessary, to select "Differential or Single Ended" indicating the type input to the sensor.

When all fields are complete, press [ENTER] to accept and save. The screen will return to the "Manage Sensors" screen. From that screen, press [BACKUP] repeatedly until the Main Menu is again displayed.

22. From the Main Menu, select "Fan / Turbine Balance"

Model 4040 VIPER Analyzer				
Main Menu				
Propeller Balance				
Main Rotor Track & Balance				
Tail Rotor Balance				
Fan/Turbine Balance				
Vibration Spectrum Surveys				
Overall Vibration Surveys				
Transient Vibration Surveys				
Monitor Spectrum				
Monitor Magnitude and Clock				
Monitor Magnitude and Phase				
Monitor Overall				
Check Track				
Transfer Data with PC				
Miscellaneous Items				
Show Forms				

23. If there are other setups already in the analyzer, the Setup List banner screen will be displayed. From that screen, press the [F1] “New” key. If no setups are in the analyzer, the “Fan / Turbine Balance Setup” screen will be displayed. Complete the Balance Setup screen as follows:
24. Complete the Fan/Turbine Balance Setup screen as follows:
- 24.1 Use the keypad to enter “TFE731-2” in the **Name:** field. Press the ↓ key to move to the next field.

Model 4040 VIPER Analyzer	
Fan/Turbine Balance Setup	
Name:	TFE731-2
Num Engs:	1
Eng Rotation:	CW
Num Baln Planes:	1
Num Optional Planes:	0
Balance Wt Type:	Class
Num Class Wt Sets:	1
Label Detail Wts:	No
Baln Weight Unit:	g
Num Sens / Eng:	1
Num Baln Speeds:	Sel. in Job
Slow Roll RPM:	0
Min Baln RPM:	5000
Actual RPM @ 100%:	11480
Vib Unit:	IPS
Modifier:	Peak

- 24.2 In the **Num Engs:** (number of engines) field, use the ⇒ key to select a number that indicates the number of engines that will be balanced using this setup. This is typically “1”. Press the ↓ key to move to the next field.
- 24.3 In the **Eng Rotation:** field, use the ⇒ key to select “CW” indicating the fan rotates clockwise as viewed from the front looking into the intake. Press the ↓ key to move to the next field

- 24.4 In the **Eng Rotation:** field, use the ⇒ key to select “CW” indicating the fan rotates clockwise as viewed from the front looking into the intake. Press the ↓ key to move to the next field.
- 24.5 In the **Num Balan Planes:** (number of balance planes) field, use the ⇒ key to select “1”. Press the ↓ key to move to the next field.
- 24.6 In the **Balance Wt Type:** field, use the ⇒ key to select “Class”. The class weights will be defined on another page. Press the ↓ key to move to the next field.
- 24.7 In the **Num Class Wt Sets:** (number of class weight sets), use the ⇒ key to select “1”. The TFE731-2 has one class weight set that may be used to trim balance the engine. Press the ↓ key to move to the next field.
- 24.8 In the **Label Detail Wts:** field, use the ⇒ key to select “No”. Detail weights are those weights which cannot be removed and occupy holes normally used for adding trim balance weights. If the answer is yes in this field, the analyzer will optimize the balance solution on available holes only. Press the ↓ key to move to the next field.
- 24.9 In the **Baln Weight Units:** field, use the ⇒ key to select “g’ for grams. The class weights for the TFE731-2 are measured in grams. Press the ↓ key to move to the next field.
- 24.10 In the **Num Sens / Eng:** field, use the ⇒ key to select 1. Press the ↓ key to move to the next field.
- 24.11 In the **Num Baln Speeds:** field, use the ⇒ key to select the total number of speeds (up to 9) you will use for this setup. Optionally, you may choose “Select in Job” which will allow you to specify the number of balance speeds with each new job rather than defaulting to a number you select here in the setup. Three speeds are recommended for balancing the TFE731-2 . Press the ↓ key to move to the next field.
- 24.12 In the **Slow Roll RPM:** field, use the keypad to enter “0”. Slow roll is a compensating RPM for use in engine applications where proximity probes are used and does not apply to this engine. Press the ↓ key to move to the next field.
- 24.13 In the **Min Baln RPM:** field, use the keypad to enter the minimum speed at which this engine can be balanced. This speed will normally be a speed in the flight range. Press the ↓ key to move to the next field.
- 24.14 In the **Actual RPM @ 100%:** field, use the keypad to enter the speed of the fan at 100% rpm. For the TFE731-2, this speed is 11480 RPM. Press the ↓ key to move to the next field.
- 24.15 In the **Vib Unit:** field, use the ⇒ key to select “IPS”. The TFE731-2 engine is balanced using velocity units of inches per second. Press the ↓ key to move to the next field.
- 24.16 In the **Modifier:** field, use the ⇒ key to select “Peak”. When all fields are complete, press [ENTER] to accept and continue.

25. The Define Class Weights banner screen will be displayed where each of the class weights used for the TFE731-2 fan trim balance will be added to the setup. Complete each field in the screen as follows:
- 25.1 In the **Name or PN:** field, use the keypad to enter a commonly known name, such as DASH WEIGHTS or the actual part number (3072593-X) of the class weight set. This is the part number, which identifies the class weight set used for the TFE731-2.

Model 4040 VIPER Analyzer
Define Class Wts

Name or PN: DASH
Num Wts: 11

Name	Wt	Span	Name	Wt	Span
(The min wt must be a base wt)					
NIL	0.000	1			
-1	2.250	1			
-2	4.520	1			
-3	6.800	1			
-4	8.690	1			
-5	11.44	1			
-6	1.130	1			
-7	3.390	1			
-8	5.660	1			
-9	7.750	1			
-10	10.07	1			

- 25.2 In the **Num Wts:** field, use the keypad to enter a total number of weights in this class weight set, 10, plus 1 NIL Wt. for a total of 11. The first weight will be the NIL weight which means a negative or null weight having no influence on the balance but necessary to fill a hole not being used for balance weights. Press the ↓ key to move to the next field.
- 25.3 In the **Name, Wt,** and **Span** columns, enter the information as shown in the illustration above for the class weights. The name will be the dash (-) number of the individual weights, the weight, as measured in grams, for each individual class weight and the span is the number of holes each individual weight covers when installed. When all information is entered as shown, press [ENTER] to accept and continue.
- 25.4 When all information is completed, press [ENTER] to accept and continue.
26. The Balance Plane information screen, shown below, will be displayed. Complete each field in the screen as follows:
- 26.1 In the **Plane ID:** field, use the ⇒ key to select the plane identification number (if optional planes were selected). Press the ↓ key to move to the next field.
- 26.2 In the **Num Holes :** field, use the keypad to enter “8”. Press the ↓ key to move to the next field.
- 26.3 In the **Hole Num Dir :** use the ⇒ key, if necessary, to toggle the field to read “CCW” for counter clockwise. This indicates the numbering direction of the weight holes is in a

counter clockwise direction as viewed from forward of the engine looking into the intake. Press the ↓ key to move to the next field.

Model 4040 VIPER Analyzer				
Balance Plane Information				
Plane ID:	1	Num Holes:	8	
Hole Num Dir:	CCW	Spacing:	Even	
MaxWt/Hole:	11.44	MaxWt/Plane:	34.32	
Wt Set:	DASH	Trial Wt:	6.80	
Angle of No.1 Hole:	0			

- 26.4 In the **Spacing:** field, use the ⇌ key, if necessary, to toggle the field to read “Even” indicating that the eight weight holes are evenly spaced. Press the ↓ key to move to the next field.
- 26.5 In the **MaxWt/Hole :** field, use the keypad to enter a value equal to the maximum amount of weight that may be added to each hole. In this case, that value is the weight of the largest weight in the class weight set, 11.44 grams for the –5 weight. Press the ↓ key to move to the next field.
- 26.6 In the **MaxWt/Plane :** use the keypad to enter a value equal to the maximum total allowable for all weights on the fan. The maximum weight per hole is 11.44 grams and the maximum number of allowable weights is three on adjacent holes for a total of 34.32 grams. Enter 34.32. Press the ↓ key to move to the next field.
- 26.7 In the **Wt Set :** field, use the ⇌ key, if necessary, to toggle the field to read the name or part number of the class weight defined earlier in step 25. Press the ↓ key to move to the next field.
- 26.8 In the **Trial Wt:** field, use the analyzer keypad to enter the weight of a single class weight (from the class weight set being used) you wish to use as a trial weight. This weight is intended only to change the measured condition of the first run so that an influence calculation can be made for the fan based on the measured change. A class weight value in the mid range of the set is acceptable for this trial weight. Press the ↓ key to move to the next field.
- 26.9 In the **Angle of No.1 Hole :** field, use the keypad to enter “0”. This indicates the No. 1 hole is at 0 (360) degrees. Press [ENTER] to accept the settings and proceed.
27. The Sensor Information screen will be displayed. Complete the screen as follows:
- 27.1 In the **Eng ID:** field, use the keypad to enter a single numeric value of 1 to 4, indicating the position of the engine being balanced. Press the ↓ key to move to the next field.

Model 4040 VIPER Analyzer				
Sensor Information				
Eng ID:	1			
Tach Chan:	1	Tach Type:	Optical	
Tach Pos (FLA):	6:00			
Full Scale Vibration:	1.00			
Sensor Type	Cha	Desc	Pos	Targ
991V	A	Fan	12	2.100

- 27.2 In the **Tach Chan:** field, use the \Rightarrow key to select the tach channel you wish to use. This must be the tach channel, 1, 2, 3, or 4, where you connect the tach input cable for this engine. Press the \Downarrow key to move to the next field.
- 27.3 In the **Tach Type:** field, use the \Rightarrow key to select the type of tachometer you are using. If using a Lasetach or Phototach, select Optical. Press the \Downarrow key to move to the next field.
- 27.4 In the **Tach Pos (FLA):** (tachometer position as viewed from forward looking aft), use the \Rightarrow key to select a clock position where the laser beam strikes the spinner when power to the laser is on. This should be approximately 6:00 for most applications. Press the \Downarrow key to move to the next field.
- 27.5 In the **Full Scale Vibration:** field, use the \Rightarrow key to select the highest amplitude you reasonably expect to experience for this balance job. Amplitude of 1 IPS is sufficient for the TFE731. Press the \Downarrow key to move to the next field.
- 27.6 In the **Sensor Type** column, use the \Rightarrow key to select a sensor from those sensors programmed into your analyzer. Press the \Downarrow key to move to the next field.
- 27.7 In the **Cha** field, use the \Rightarrow key to select the channel you will connect the incoming vibration signal to, A, B, C, or D. Press the \Downarrow key to move to the next field.
- 27.8 In the **Desc** field, use the keypad to enter a description of the channel-identified sensor such as #1, Fan or L. Press the \Downarrow key to move to the next field.
- 27.9 In the **Pos** (position) field, use the \Rightarrow key to select the approximate clock position of the vibration sensor on the engine as viewed from forward looking aft into the intake. If you are not sure of the position, select "UNK" for unknown. The analyzer will compensate for the unknown position and locate it automatically with one additional engine run. Press the \Downarrow key to move to the next field.
- 27.10 In the **Targ** (target amplitude) field, use the keypad to input amplitude you wish to achieve as a maximum acceptable vibration using this setup. The analyzer will continue

to provide solutions until this value is achieved. When all fields are complete, press [ENTER] to accept. The screen below will be displayed asking, “Store this new setup?” Press the [F1] “Yes” key to save or the [F5] “No” key to return to the setup.

Model 4040 VIPER Analyzer				
Model 4040 VIPER Analyzer				
Store this new setup?				
Yes				No

28. After the setup is stored you may turn the analyzer off or proceed to the balance procedure. If you continue with the balance, the customer information screen below will be displayed. The information on this screen is optional and need not be filled in to continue with the job, however; this information will assist you in your record keeping efforts and greatly reduce the effort in recalling the job later from the analyzers memory or for the AvTrend database. Use the keypad to enter the Name, Aircraft Registration, and total aircraft time. If you have entered other names in the Name field previously, you may press the [F1] key and select from a list containing those stored names. When all fields are complete, press [ENTER] to accept and continue.

Model 4040 VIPER Analyzer				
Customer Information				
Enter the following optional Customer information.				
Name: <input type="text"/>				
A/C Registration: <input type="text"/>				
A/C Total Time: <input type="text" value="0.0"/>				
Press ENTER to continue				
Names				

29. If you elected to Select Balance Speeds in the Job (see step 24.10 above) the “Define Fan/Turbine Balance RPM” banner, shown below, will be displayed. Complete the screen as follows:

- 29.1 In the **Num Baln Speeds:** field, use the \Rightarrow key to select the number of balance speeds for this job. You may choose up to nine speeds. Three (3) speeds are recommend for the TFE731-2. Press the \Downarrow key to move to the next field.

Model 4040 VIPER Analyzer	
Define Fan/Turbine Balance RPM	
Num Baln Speeds: 3	
Entered RPM Relative to Peak: No	
Spd	N%/RPM
1	0.0
2	0.0
3	0.0
Enter N% or RPM	
Survey	

- 29.2 In the **Entered PRM Relative to Peak:** field, use the \Rightarrow key to toggle the answer field to Yes or No as appropriate indicating whether or not the speeds are relative to the peak vibration of a survey. “No” is normally the case unless the engine manufacturer specifies the balance speed as the Peak plus or minus a speed value. Select “No” for the TFE731. Press the \Downarrow key to move to the next field.
- 29.3 The **Peak Speed:** field will be displayed ONLY if you answered “YES” to the filed in step 29.2 above. This field should not normally be used for the TFE731. Press the \Downarrow key to move to the next field.
- 29.4 The **Spd** column will contain a number of rows relative to the number of balance speeds you specified in step 29.1 above. Immediately to the right of those numbers, in the **N%RPM** column, use the keypad to enter the balance speeds. If you wish to conduct a Fan Vibration Survey at this point to determine the balance speeds, press the [F1] “Survey” key and follow the instructions on screen. When all fields are complete as necessary, press [ENTER] to accept and continue.
30. The Define Fan / Turbine Balance ICFs banner screen will be displayed. Complete the screen as follows:
- 30.1 In the **All Speeds Use the Same ICF:** field, use the \Rightarrow key to toggle the answer field to Yes or No as appropriate. If you have individual coefficient influences for each speed, answer No, otherwise answer Yes. Press the \Downarrow key to move to the next field.
- 30.2 In the **1** row, and in the **g/IPS** (grams per IPS) column, enter “30.70” to indicate an influence of 30.7 grams per IPS. Press the \Downarrow key to move to the next field.
- 30.3 In the **1** row, and in the **Deg** (Degrees) column, enter 325.

Model 4040 VIPER Analyzer				
Define Fan/Turbine Balance ICFs				
Plane ID: 1				
All Speeds Use the Same ICF: <input checked="" type="checkbox"/> Yes				
Spd Sensor 1				
g/IPS Deg				
1	30.70	325		

- 31 The Fan / Turb Balance Equipment Setup screen will be displayed. Follow the on screen instructions for installing and attaching sensors and cables. Notice that there is a message near the center of the screen reading “Tach power is off”. This indicates the tachometer circuit is currently not powered for alignment of the Lasetach. If you are ready to align the Lasetach, press the [F1] “Tach On” key to power the laser and proceed to the LASER ALIGNMENT procedure on page 19 of this document. When the laser alignment is complete, return to this point and continue.
- 31.1 If the laser alignment is complete, press [ENTER] to continue. The power indication for the tach may be left in either the On or Off position when exiting this screen.

Model 4040 VIPER Analyzer				
Fan/Turb Balance Equipment Setup				
Install the speed sensor and connect to tach channel 1				
Install vibration sensor and connect to vib. channel A				
Tach power is Off				
Tach On				

- 32 The Start Aircraft banner screen will be displayed. The Run number is indicated at the top left of the screen followed by the information message “Remove all trim weights.” Insure all previously installed trim balance weights have been removed. Start the engine(s) and watch for the Current RPM indication on the analyzer screen. When an indication of RPM is noted, allow the engine to warm up to normal operating temperature then accelerate the engine until the Current RPM and the Desired PRM on screen match as closely as possible. The Difference indication will show how many RPM difference there is between the Current and

the Desired RPM. When the speeds are matched, allow the engine to stabilize for a short time and make any minor adjustments necessary, and then press [ENTER] to continue.

Model 4040 VIPER Analyzer				
Start Aircraft				
Run 1				
Remove all trim weights.				
Start engine(s) per flight manual				
Current RPM: 400				
Desired RPM: 8500				
Difference : -8100				
When speed is stable at desired speed, press ENTER to continue.				

C. Data Acquisition

33. The Run 1, Spd 1, Sen 1 banner screen shown below will display the information for the first run. Indications of the Current and Average RPM, Vibration amplitude, and phase angel are displayed to the right of the converging scale. See the Viper 4040 User manual, chapter 20, Reading Spectrum and Scales for a detailed description of how to read the converging scale. After indications are stable, press [ENTER] to accept the collected data and continue. This screen will repeat for each of the speeds specified for balance. When all speeds are collected, the screen will automatically proceed to the shutdown message below in step 34.

Model 4040 VIPER Analyzer				
Run : 1 Spd : 1 Sen : A				
	Current 1			
	RPM 832			
	Vib 0.39			
	Phase 338			
	Average			
	PRM 8290			
	Vibe 0.36			
	Phase 290			
	Error 0.01			
	1 : A			
Reset				

34. The Shutdown Aircraft message will be displayed. Press the [F5] “Continue key to acknowledge and proceed with a normal engine shutdown procedure.

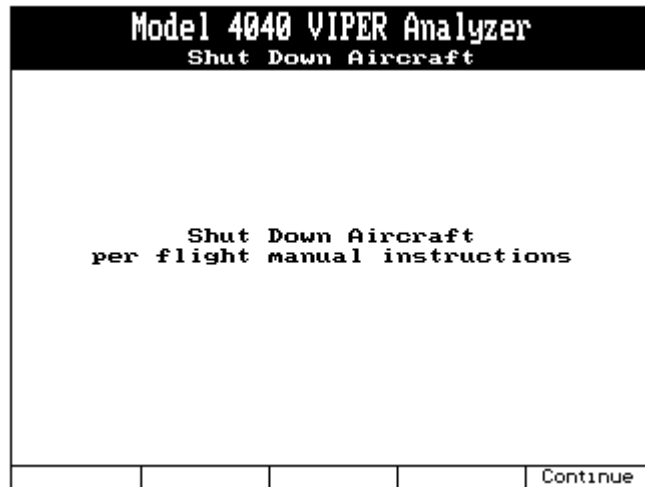

35. The Review Prior Run(s) Data will be displayed for your review of the data collected up to this point. You may view data from all runs by scrolling through the available run data using the ⇐ and ⇒ keys. Optionally you may use the [F1] and [F2] keys to Retake One or Retake All data as required. When you are satisfied with the review, press [ENTER] to continue.

Note

Data shown in these screens are for illustration only and do not reflect actual data corresponding to the TFE731 engine.

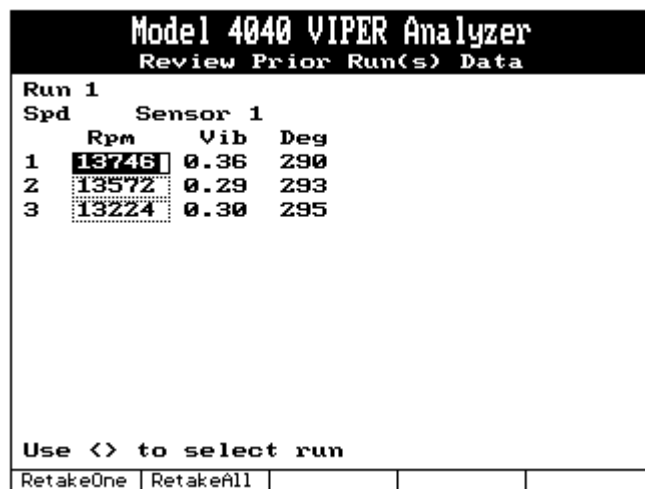

36. The Fan / Turb Suggested / Installed Wts screen will be displayed. Notice the first line of text in the screen shows the Run number and the message “Remove Old Wts, Inst. New Wts.”

Remove all previously installed trim weights from any previous run and install the weights in the “Suggested” column in the hole numbers indicated to their immediate left. The right side of the screen reflects what you have actually installed. Be sure the information in the Hole/Bld and Installed column is correct before exiting this screen. If you install the exact suggested weight, you need only press the [ENTER] key to exit this screen with that information. If you installed different weights or installed weights in different holes than those suggested, use the arrow keys to navigate the matrix and indicate your exact installation. This is very important in that the analyzer will use this information to calculate an influence for subsequent runs. Notice the function keys at the bottom of the screen are labeled for the options of “Inst=Sugg” (install the suggested weights in the suggested holes), “Inst=None” (Install None or no weights), “Sel Pla/W” (select a different Plane or weight set), and “Quit Job” When all fields are complete, press [ENTER] to accept and continue.

Model 4040 VIPER Analyzer			
Fan/Turb Suggested/Installed Wts			
Run 1 Remove Old Wts, Inst. New Wts			
Name: Plane 1, 23071354-X			
Hole/Bld	Suggested	Hole/Bld	Installed
6	-4	6	-4
5	-5	5	-5
4	-5	4	-5
3	-5	3	-5
2	-1	2	-1
1	NILL	1	NILL
1	NILL	1	NILL
1	NILL	1	NILL
1	NILL	1	NILL
1	NILL	1	NILL
1	NILL	1	NILL
Total: Sugg = 29.536 @ 261			
Total: Inst = 29.601 @ 261			
Inst=Sugg	Inst=None	Sel Pla/W	Quit Job

37. The Start Aircraft banner screen will be displayed for the next sequential run as indicated in the upper left portion of the screen. From this point, the sequence of events from paragraph will repeat until the fan vibration is reduced to an acceptable level. Normally this goal will be attained in one to three runs.

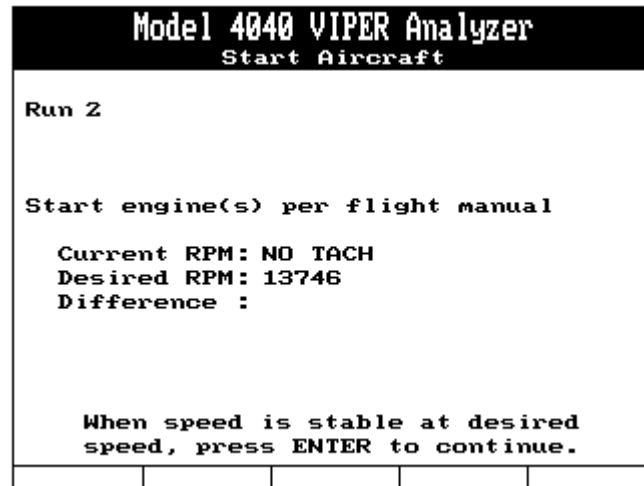

LASER ALIGNMENT

1. Rotate the fan until the reflective tape on the spinner is positioned at the 6:00 position. Clock position is determined from a position forward of the engine, looking aft into the intake.
2. Ensure the Lasetach is securely mounted and connected as described in Equipment Setup. Also check to make sure the Lasetach is securely mounted to the Swivel Head of the Lasetach Mount. If it is loose, tighten by turning the Lasetach clockwise on the mounting stud while holding the Swivel head with the other hand.
3. Remove the plastic aperture cap from the Lasetach.
4. Turn the Laser **ON/OFF** switch on top of the Lasetach to the **ON** position.
5. The **BEAM ON** indicator (red) light adjacent to the Laser **ON/OFF** switch should now be illuminated.
6. Place the open palm of your hand in front of the aperture. The laser beam should be visible on your palm.

WARNING

Do not look into the aperture of the Lasetach. Avoid direct eye exposure. Eye damage may occur due to direct exposure to laser radiation.

7. Loosen the Locking Handle of the Lasetach mount (see figure below) so that the Lasetach swivels with a slight friction. Using the “gunsight” method, sight along the side of the Lasetach using one hand while holding the Locking Handle with the other. If you have trouble acquiring the laser beam visually, you may use a free hand to sight on. No injury will occur as a result of the laser being projected on your skin. You may also choose to have someone hold a sheet of white bond paper near the target for easier acquisition. When the laser beam strikes the tape, it will be very visible. When the laser is on target, center the beam

on the length of the tape and immediately tighten the Locking handle by turning it clockwise. Release both hands and recheck the alignment.

8. The laser beam should now be striking approximately in the center of the two-inch span of the tape. If minor adjustments are necessary, loosen the Locking Handle only SLIGHTLY. Make adjustments as necessary and re-tighten.
9. When satisfied with the laser position, rotate the fan several times. When the tape passes through the laser beam, the GATE (green) light on the Lasetach should turn on as the tape enters the beam and off as it exits. If this test is successful, return to the cockpit and continue with step 31.1 of this procedure.

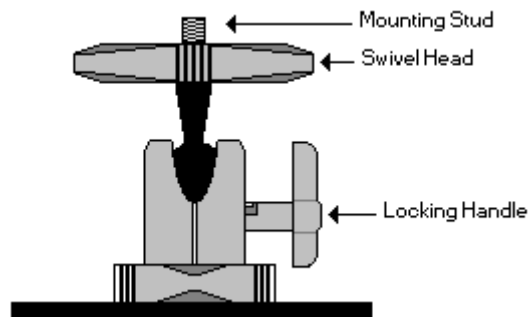



Application Note

Engine Type : TFE731-2

Procedure : Fan Trim Balance

Part Number: 11-200-0120

AppNote Number: E-HO-TFE731-2-4040-FB

This Application Note is provided for information only and does not supercede the requirements or guidelines set forth in the applicable engine or airframe maintenance manual. Technology for Energy Corporation assumes no obligation or liability, either express or implied, to the Purchaser arising out of the use of this procedure.

Copyright © 2002, TEC Aviation Division. All rights reserved. This document is to be printed and reproduced for personal use only.